

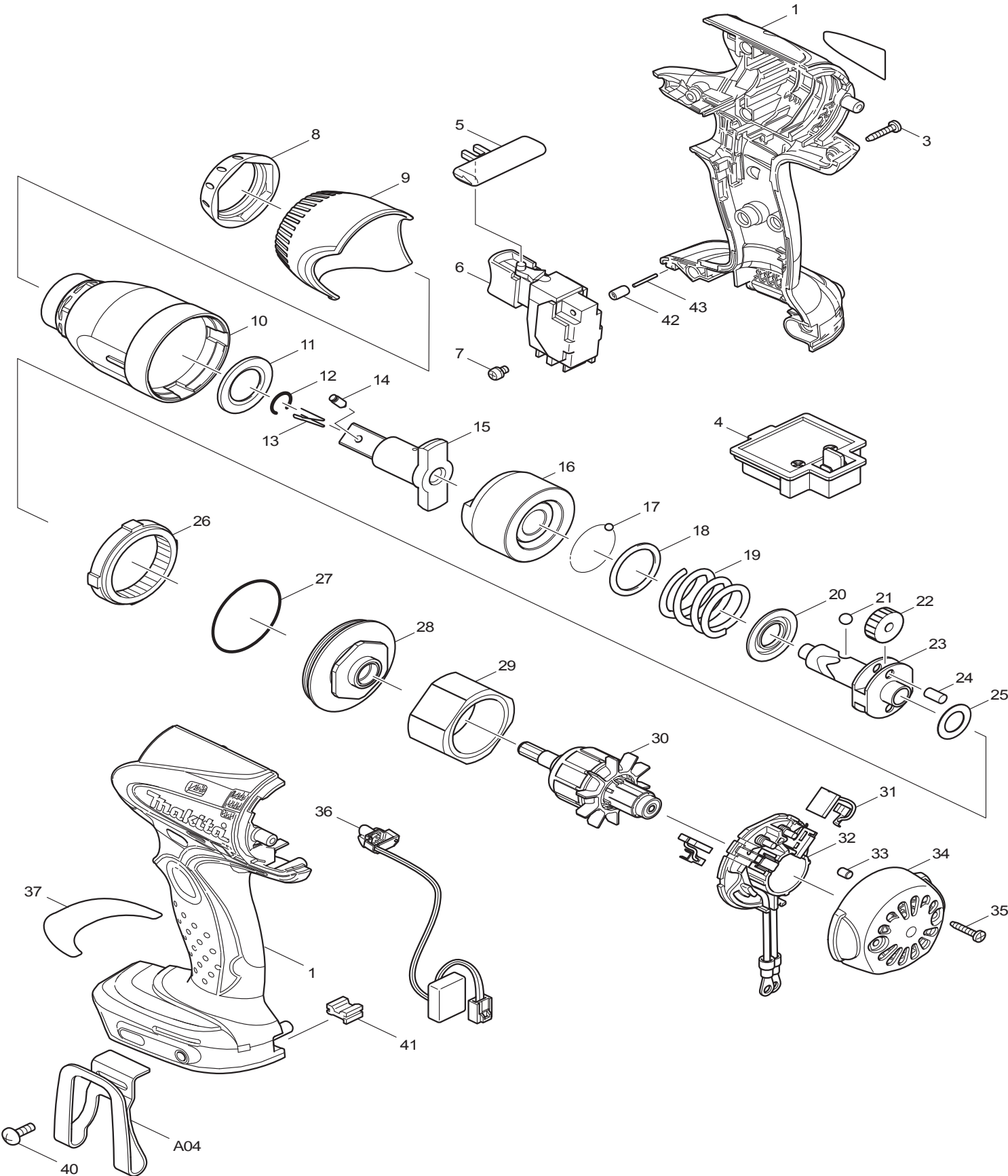

08-2010
BTW250/ BTW250Z
14.4V 1/2" IMPACT WRENCH KIT



Item No.	Type	Sub	Parts No.	Description	Qty	Unit
1	1		188192-6	* HOUSING SET	1	SET
		INC.	263005-3	* RUBBER PIN 6	2	PC.
	2		188242-7	* HOUSING SET	1	SET
		INC.	263005-3	* RUBBER PIN 6	2	PC.
	3		187466-2	* HOUSING SET	1	SET
		INC.	263005-3	* RUBBER PIN 6	2	PC.
3			266130-9	TAPPING SCREW BIND PT 3X16	8	PC.
4	1		643811-6	* TERMINAL	1	PC.
	2		643866-1	* TERMINAL	1	PC.
5			419041-9	F/R CHANGE LEVER	1	PC.
6	1		650564-0	* SWITCH TG553FSB-1	1	PC.
	2		650652-3	* SWITCH TG553FSB-1B	1	PC.
7			652045-0	+PAN HEAD SCREW M3.5X5	2	PC.
8	4		424375-7	* BUMPER	1	PC.
9	4		452439-7	* HAMMER CASE COVER	1	PC.
10	3		140171-2	* HAMMER CASE COMPLETE (TYPE 3-4)	1	PC.
11			261116-8	NYLON WASHER 18	1	PC.
13			322045-1	CLIP	1	PC.
14			323675-1	PIN 4	1	PC.
15			324704-3	ANVIL	1	PC.
16			324703-5	HAMMER	1	PC.
17			216001-0	STEEL BALL 3.5	24	PC.
18			267175-0	FLAT WASHER 24	1	PC.
19	1		233478-4	* COMPRESSION SPRING 25	1	PC.
	2		234082-2	* COMPRESSION SPRING 25	1	PC.
	3		234337-5	* COMPRESSION SPRING 25	1	PC.
20			267766-7	CUP WASHER 14	1	PC.
21			216011-7	STEEL BALL 5.6	2	PC.
22	1		227027-7	* SPUR GEAR 22 - N/L/A	2	PC.
	2		227233-4	* SPUR GEAR 22	2	PC.
23			324220-5	SPINDLE	1	PC.
24			256253-1	PIN 5	2	PC.
25			267212-0	FLAT WASHER 12	1	PC.
26			227150-8	INTERNAL GEAR 51	1	PC.
27			213507-9	O RING 40	1	PC.
28			158145-9	BEARING BOX COMPLETE	1	PC.
		INC.	211140-1	BALL BEARING 6901LLB	1	PC.
29			638495-3	YORK UNIT	1	PC.
30	1		619192-0	ARMATURE - N/L/A	1	PC.
	2		619251-0	ARMATURE	1	PC.
31	1		194427-5	* CARBON BRUSH CB-440, 2PCS/SET, W/O ORIGIN - N/L/A	1	SET
	2		195021-6	* CARBON BRUSH CB-440, 2PC/SET (W/ ORIGIN) (TYPE 2-3)	1	SET
32			638498-7	BRUSH HOLDER COMPLETE	1	PC.
33			263032-0	RUBBER PIN 4	2	PC.
34			418981-8	REAR COVER	1	PC.
35			266130-9	TAPPING SCREW BIND PT 3X16	2	PC.
36			631631-0	LIGHT CIRCUIT	1	PC.
37			810292-1	CAUTION LABEL	1	PC.
40			251314-2	+ SCREW M4X12	1	PC.
41			424026-2	CUSHION	1	PC.
42			263036-2	RUBBER PIN 5	1	PC.
43			268184-2	PIN 1.5	1	PC.
ACCESSORIES			- See catalogue or visit www.makita.ca for optional accessories -			
A01	1		DC18RA	CHARGER DC18RA	1	PC.
	2		DC18RC	CHARGER DC18RC	1	PC.
A02			194066-1	14.4V LI-ION BATTERY BL1430	1	PC.

Item No.	Type	Sub	Parts No.	Description	Qty	Unit
A03	1		824753-5	PLASTIC CARRYING CASE	1	PC.
		INC.	324207-7	SHAFT	1	PC.
		INC.	413098-2	PLATE	4	PC.
		INC.	417724-5	LATCH	2	PC.
		INC.	419216-0	HANDLE	1	PC.
		INC.	419215-2A	PLASTIC CASE LID, TAB TYPE	1	PC.
	2		141205-4	PLASTIC CASE COMPLETE F/ DC18RC	1	PC.
		INC.	324207-7	SHAFT	1	PC.
		INC.	413098-2	PLATE	4	PC.
		INC.	417724-5	LATCH	2	PC.
		INC.	419216-0	HANDLE	1	PC.
		INC.	419215-2A	PLASTIC CASE LID, TAB TYPE	1	PC.
A04	1		324705-1	HOOK (F/ BL1430, BL1830)	1	PC.
	2		346449-3	* HOOK (F/ BL1430, BL1830)	1	PC.
A05			450128-8	BATTERY COVER	1	PC.
A06			194649-7	BATTERY PROTECTOR (F/ BL1430, BL1830)	1	PC.
A07			134874-8	EXTENSION BAR 1/2" DRIVE	1	PC.
A08			134873-0	B/T ADAPTOR 1/2" DRIVE BIT	1	PC.
A09			134877-2	UNIVERSAL JOINT 1/2" - LARGE	1	PC.

SERVICE CHANGES

1. Changes on Hammer Case, Bumper

Item No.	Description	Type 1	Type 2	Type 3	Type 4
8	Bumper	421964-9 (N/L/A)	424155-1 (Green)	424155-1 (Blue)	424375-7
9	Hammer Case Cover	419514-2	450808-6	451361-5	452439-7
10	Hammer Case Com.	158144-1 (N/L/A)		140171-2	

Above parts are completely interchangeable as a set.
 Type 2 and Type 3 Bumper are interchangeable as themselves.

Type 1 >> Type 2 (T/l# 81628)

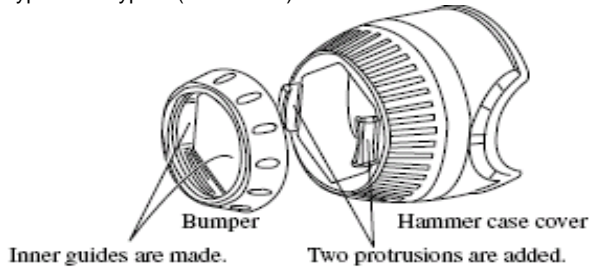

Type 2 >> Type 3 (T/l# 84119, 83269)

Hammer case complete

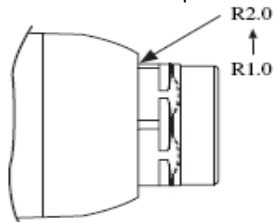

Hammer case cover

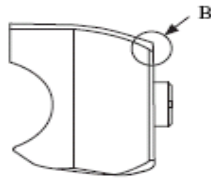

enlargement of B

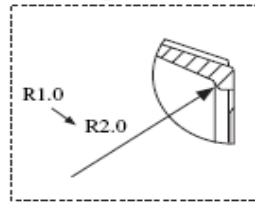

Type 3 >> Type 4 (T/l# 89111)

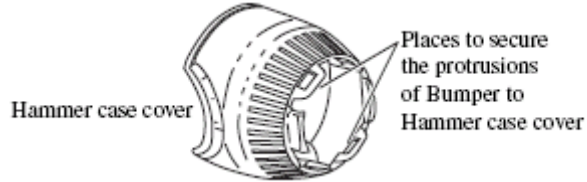

SERVICE CHANGES

2. Changes on Spur gear and compression spring

Item No.	Description	Type 1	Type 2	Type 3
19	Compression spring 25	233478-4	234082-2	234337-5
22	Spur gear 22	227027-7	227233-4	

Above parts are completely interchangeable as a set.

(T/I #81503)

(T/I #A2541)

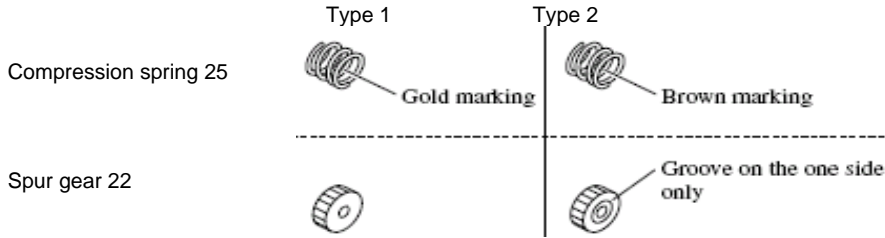

Compression spring 25
Type2

Free length: 29.2 mm

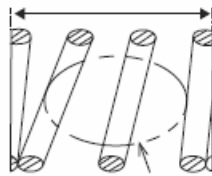

Brown paint marking(234082-2)

Type3

Free length: 28.2 mm

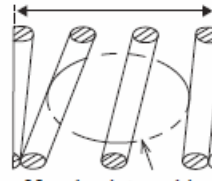

Navel paint marking(234337-5)

3. Changes on How to Assembly Carbon Brushes

Item No.	Description	Without Origin	With Origin
31	Carbon Brushes	194427-5	195021-6

Do not protrude the pigtails of Carbon brushes from the specific spaces.

Refer to the following illustration.

(T/I# 89544)

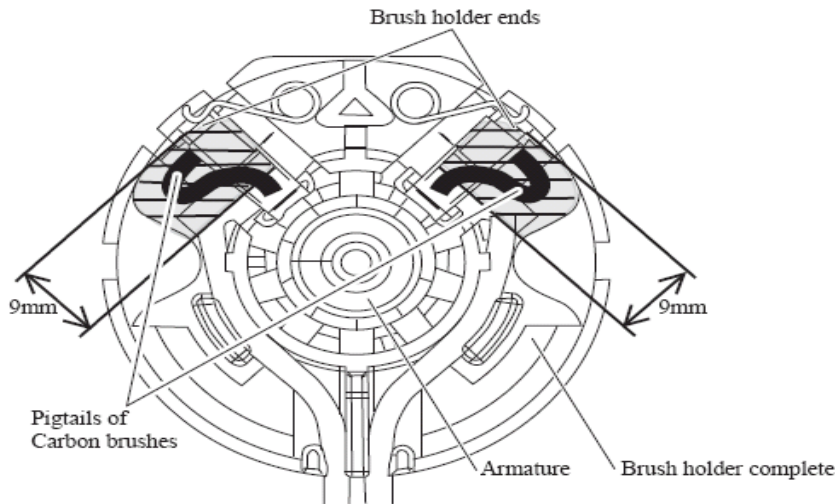

SERVICE CHANGES

4. Changes on Switch, Terminal and Housing Set (Battery Protection Circuit)

(T/I# 80432) (T/I# 91081)

Item No.	Description	Type 1	Type 2	Type 3
1	Housing Set	188192-6	188242-7	187466-2
4	Terminal		643811-6	643866-1
6	Switch		650564-0	650652-3

Above parts are completely interchangeable as a set.

Service Note:

- Use TYPE 3 parts for repair of the models manufactured on or after July 2011 with using Yellow lead wire between Switch and Terminal.
- Use TYPE 2 (or TYPE 1) parts for repair of the models manufactured before July 2011 without using Yellow lead wire between Switch and Terminal.

**** See Technical Information #91081 for Wiring Diagram Change**

5. Changes on Hook

Item No.	Description	Type 1	Type 2
A04	Hook	324705-1	346449-3

