

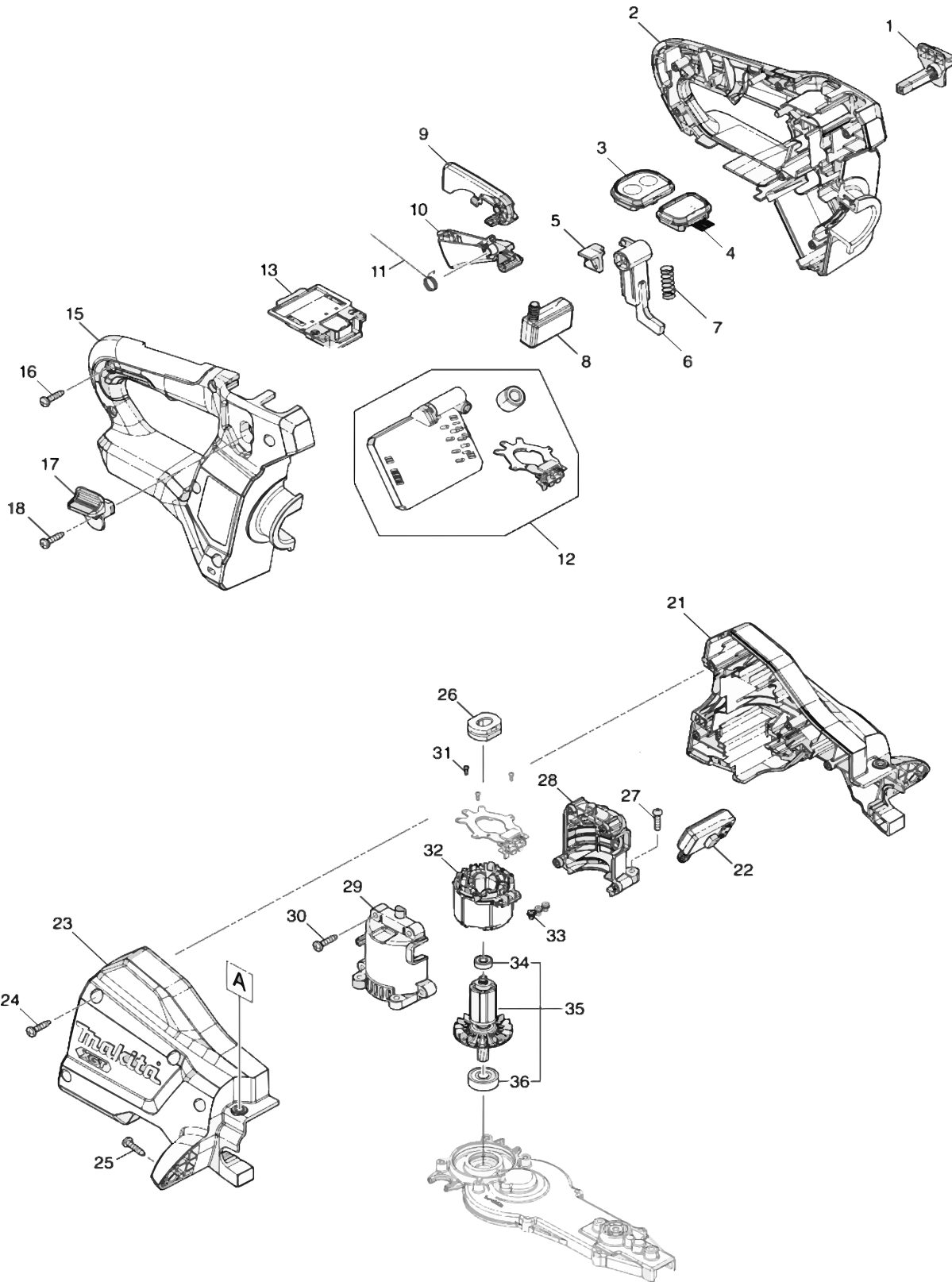

GHU01



Products with multiple versions are listed in subsiding order with the newest version on top not indented.

Section	Fig. No.	Part No.	Description	GHU01	Tech Bulletin	Notes
1	1	458406-0	LOCK LEVER L	1		
1	2	183T64-0	HANDLE SET	1		INC. 15
1	3	141D66-6	SWITCH CIRCUIT COMPLETE E	1		
1	4	140W63-3	INDICATION CIRCUIT COMPLETE	1		
1	5	458570-7	SLIDER	1		
1	6	458405-2	LOCK ARM	1		
1	7	234204-4	COMPRESSION SPRING 8	1		
1	8	651083-9	SWITCH C3XA-1PSPM	1		
1	9	458403-6	LOCK OFF LEVER	1		
1	10	413792-6	SWITCH LEVER R	1		
1	11	232454-5	TORSION SPRING 10	1		
1	12	620E57-1	CONTROLLER	1		
1	13	632P64-8	TERMINAL UNIT	1		
1	15	183T64-0	HANDLE SET	1		INC. 2
1	16	266326-2	TAPPING SCREW 4X18	6		
1	17	458407-8	LOCK LEVER R	1		
1	18	266326-2	TAPPING SCREW 4X18	1		
1	21	183S95-3	HOUSING SET	1		INC. 23
1	22	651083-9	SWITCH C3XA-1PSPM	1		
1	23	183S95-3	HOUSING SET	1		INC. 21
1	24	266326-2	TAPPING SCREW 4X18	4		
1	25	266326-2	TAPPING SCREW 4X18	2		
1	26	422261-6	RUBBER SLEEVE	1		
1	27	911128-8	P.H.SCREW M4X16 WITH WR	4		
1	28	183S94-5	MOTOR HOUSING SET	1		INC. 29
1	29	183S94-5	MOTOR HOUSING SET	1		INC. 28
1	30	266326-2	TAPPING SCREW 4X18	4		
1	31	266490-9	TAPPING SCREW PT 2X6	3		
1	32	629A75-2	STATOR	1		
1	33	652069-6	FLAT HEAD SCREW M3X6	3		
1	34	211157-4	BALL BEARING 695ZZ	1		
1	35	519695-3	ROTOR ASSY	1		INC. 34,36
1	36	210005-4	BALL BEARING 608DDW	1		

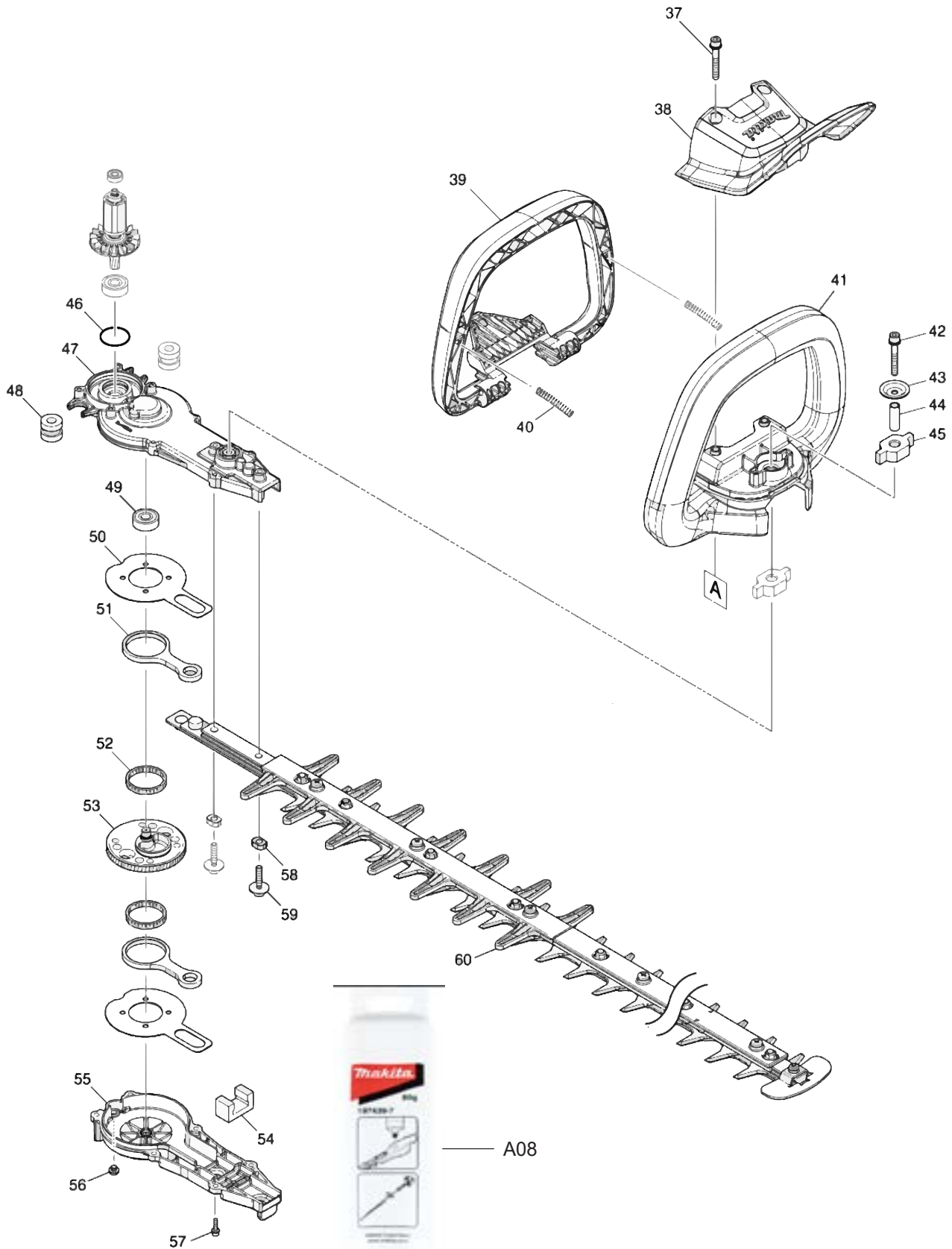

Products with multiple versions are listed in subsiding order with the newest version on top not indented.

Section	Fig. No.	Part No.	Description	GHU01	Tech Bulletin	Notes
2	37	265182-7	+ PAN HEAD SCREW M5X25	2		
2	38	458399-1	PROTECTOR	1		
2	39	458402-8	SWITCH LEVER F	1		
2	40	233222-9	COMPRESSION SPRING 5	2		
2	41	413791-8	FRONT GRIP E	1		
2	42	251476-6	H.S.H.BOLT M5X35 WITH WR	1		
2	43	253416-0	DISH WASHER 5	1		
2	44	257678-2	SLEEVE 6	1		
2	45	422260-8	RUBBER SLEEVE 8	2		
2	46	213961-7	O RING 22	1		
2	47	141C50-5	GEAR HOUSING COMPLETE	1		
2	48	422725-0	RUBBER SLEEVE 8	2		
2	49	211032-4	BALL BEARING 608ZZ	1		
2	50	347361-0	FRICTION PLATE	2		
2	51	347662-6	CONNECTING ROD	2		
2	52	212229-8	NEEDLE CAGE 315	2		
2	53	141C49-0	GEAR COMPLETE	1		
2	54	443159-4	SEAL	1		
2	55	141C46-6	GEAR HOUSING COVER COMPLETE	1		
2	56	266559-9	H.S.BUTTON HEAD BOLT M6X4	1		
2	57	922128-3	HEX. SOCKET HEAD BOLT M4X16	6		
2	58	257859-8	SLEEVE 5	2		
2	59	265A89-3	H.S.H.BOLT M5X25 WITH WR	2		
2	60	191R55-5	SHEAR BLADE 600 R SET	1		INC 58
2		413794-2	GUARD R	1		INC WITH FIG 60. NOT PICTURED
2		413795-0	SPACER 600 R	1		INC WITH FIG 60. NOT PICTURED
2		915211-3	BINDING HEAD SCREW M5X12	5		INC WITH FIG 60. NOT PICTURED
2	A01	412911-1	BLADE COVER 600	1		NOT PICTURED
2	A08	197439-7	GEAR GREASE	1		